



P W X S E R I E S



DC POWER SUPPLY

1U Multi Range Programmable DC Power Supply

PWX Series



- A next-generation, internet-enabled rack mounted power supply
- A virtual multi-channel bus (VMCB) function that fully supports multi-channel operation
- A thin and lightweight design with 1U height for increased rack-mounting efficiency
- Voltage and current range can be varied within the rated power (the ratio of 3 times)
- Rated output power: 750 W/1500 W. Rated output voltage: 30 V/80 V/230 V/650 V
- PFC circuit of 0.99 (with 100 V) or 0.97 (with 200 V) at full load *TYP value
- LAN/USB/RS232C as standard interface



Ideal for N-to-M network-based remote control and monitoring...

A Next-Generation Rack-Mounted Power Supply

1U Multi Range Programmable DC Power Supply

Thin & Wide range DC Power Supply **PWX series**

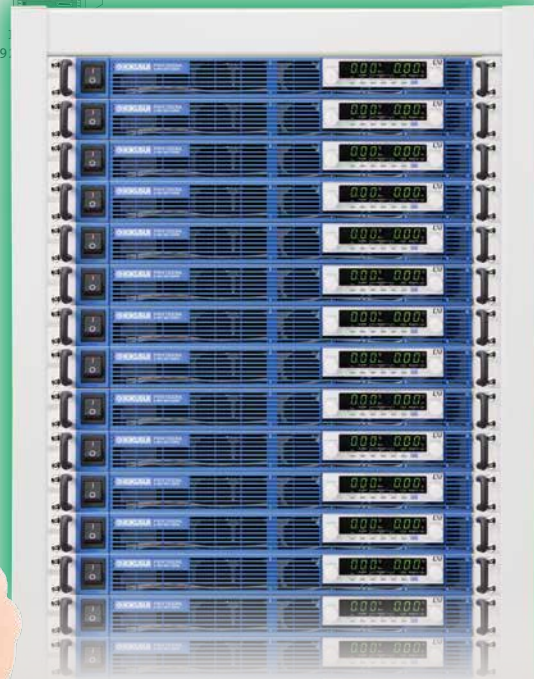
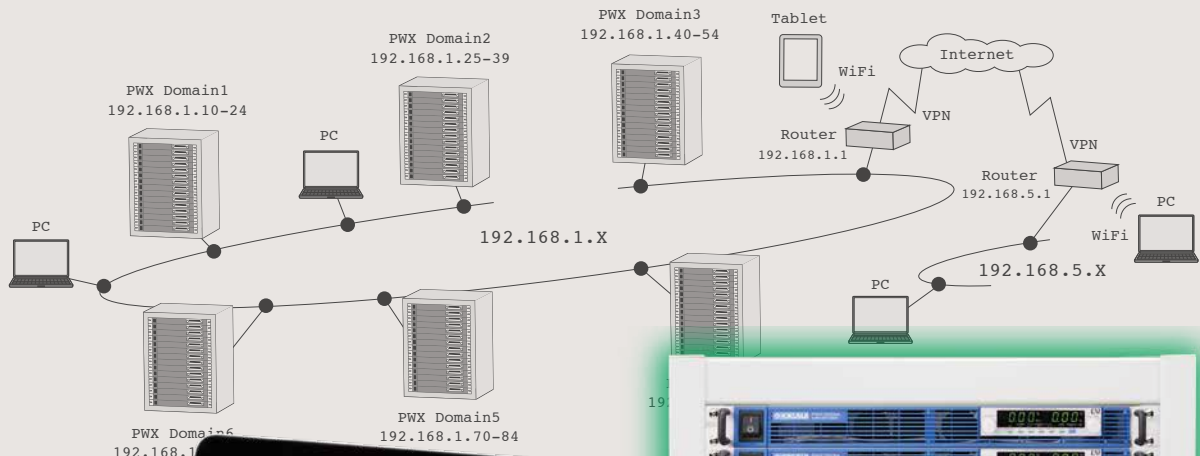



LXI
Network
 LAN (LXI: compliant),
 USB, RS232C:
 as standard interface

Thin
 1U size

Wide Range
 3 times of coverage ratio
 for the voltage and
 current range

Model	Voltage output	Current output
PWX750LF	0 to 30 V	0 to 75 A
PWX750ML	0 to 80 V	0 to 28 A
PWX750MLF	0 to 80 V	0 to 28 A
PWX750MHF	0 to 230 V	0 to 10 A
PWX750HF	0 to 650 V	0 to 3.5 A

Model	Voltage output	Current output
PWX1500L	0 to 30 V	0 to 150A
PWX1500ML	0 to 80 V	0 to 56A
PWX1500MH	0 to 230 V	0 to 20A
PWX1500H	0 to 650 V	0 to 7A

● About the name of model

(Example) **PWX** **750** **ML** **F**^{*}
 Series Output power Output [0 to 80 V/ 0 to 28 A] Cabinet size

* Indicates the cabinet size of the 750 W model (19 inches full size).
 The PWX750ML is the 19-inch half-rack size model.
 (The only half-size model available is PWX750ML.)



The PWX series is a CVCC programmable regulated DC power supply designed to optimize for a rack-mounted power supply. To increase its mounting efficiency, it has a 19-inch rack width with a thin shape and intakes and outtakes for cooling on only the front and back surfaces so that it can be mounted flush top and bottom.

The series is equipped standard with USB, RS232C, and LAN interfaces, which are essential for system upgrades. The series also has a virtual multi-channel bus (VMCB) function that allows it to be used efficiently for remote control and monitoring with 1-to-N and as well as with N-to-M in large-scale networks. In particular, the LAN interface is LXI compliant*, enabling you to control and monitor the power supply easily from a browser on a PC, smartphone, or tablet. You can also manage the power supply in a different building.

Two output power specifications are available: 750 W and 1500 W, and a wide range of voltage and current settings can be combined within its output power rating (3 times). For example, the output power of 1500 W model, the PWX1500ML is capable to operate seamlessly from the range of "80 V-18.75 A" to "26.8 V-56 A". The input voltage has a universal 85 V to 265 V input voltage range, and the unit also has an internal power factor correction (PFC) circuit to control the harmonic current. It also includes an analog external control/monitoring output, master-slave parallel operation function, various protective functions, and memory function.

*LXI: LAN eXtension for Instrumentation

- ✦ Rated output power: 750 W/1500 W
- ✦ Rated output voltage: 30 V/80 V/230 V/650 V
- ✦ A wide range of voltage and current settings can be combined within its output power rating (3 times)
- ✦ PFC circuit of 0.99 (with 100 V) or 0.97 (with 200 V) at full load *TYP value
- ✦ Supporting universal input voltage (85 V to 265 V)
- ✦ LAN (LXI compliant) /USB/RS232C as standard interface
- ✦ A virtual multi-channel bus (VMCB) function makes multi-channel operation more efficient
- ✦ Emulation setting, Command language setting function
- ✦ A thin and lightweight design with a 1U height for increased rack-mounting efficiency
- ✦ Expandable output capacity by parallel operation
- ✦ Expandable output voltage by series operation (up to 2 units by the same model)
 *Excluding the PWX750HF and the PWX1500H.
- ✦ External analog control function (Output control based on voltage and resistance; ON/OFF based on contact signals)
- ✦ Analog monitor output (output voltage, output current, and operating mode can be monitored)
- ✦ Various protection functions: overvoltage protection, overcurrent protection, and overheat protection
- ✦ Memory function (3 combinations of settings for voltage, current, OVP, OCP, and UVL)
- ✦ Remote sensing function

[Applications] For testing of the Solar system, Semiconductor test equipment, Manufacturing equipment integration, various motors testing, various experiments and evaluations, electronic component testing, automotive electronic components testing, research and development, quality control, and production line.



Equipped with standard LAN interface and VMCB function to support

The PWX series is equipped with LAN, USB, and RS232C interfaces as standard features. By using the feature of virtual multi-channel bus (VMCB)*1, it allows you to control remotely and monitoring for 1-to-N as well as N-to-M for large-scale networks. In particular, the LAN interface is LXI compliant, enabling you to easily control and monitor the power supply through a browser on a PC, smartphone, or tablet by accessing the web server built into the PWX series.

Additionally, the optional application software, Wavy for PWX (SD013-PWX), sequence creation and control software, allows you to change settings for specific channels (in individual) on VMCB-connected PWX series power supplies, and lets you perform batch control using global commands*2. You can also turn the output ON and OFF on multiple units and adjust the output voltage and current.

*1: This function for the PWX750ML applies to the firmware version 2.0 and later.
 *2: This is only enabled for "Direct control" on Wavy for PWX. Global commands that can be also used under control with VXI-11, HiSLIP, and SCPI-RAW.

● Basic configuration with LAN interface and VMCB (example)

As shown in the figure below, it is possible to connect a PC and the PWX series with a hub to create a virtual group using a LAN connection. A maximum of 255 virtual groups can be set, and the maximum number of units can be configured up to 31 units per group. A group can have a mixture of models.

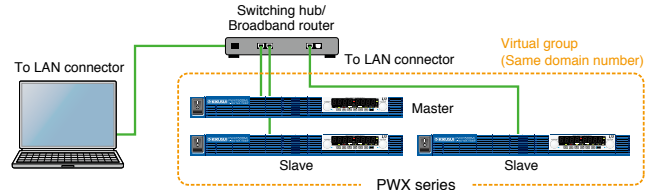

Configuration	IP address	Domain number	Channel number
Master	192.168.1.1	1	0
	192.168.1.2 *	1	1
Slave	192.168.1.3 *	1	2

* A DHCP server can also establish settings automatically

Additional feature is adopted!

Communication Monitoring function : This function monitors the communication status. For example, the alarm will be activated and the output will be turned off when the LAN cable is disconnected and the communication is not being confirmed within the specified time of setting. This function protects the operation from the uncontrolled condition, and it improves the system reliability.

* Applies to the firmware Ver.2.2X or above

[Schematic LAN network configuration with the PWX series power supply]

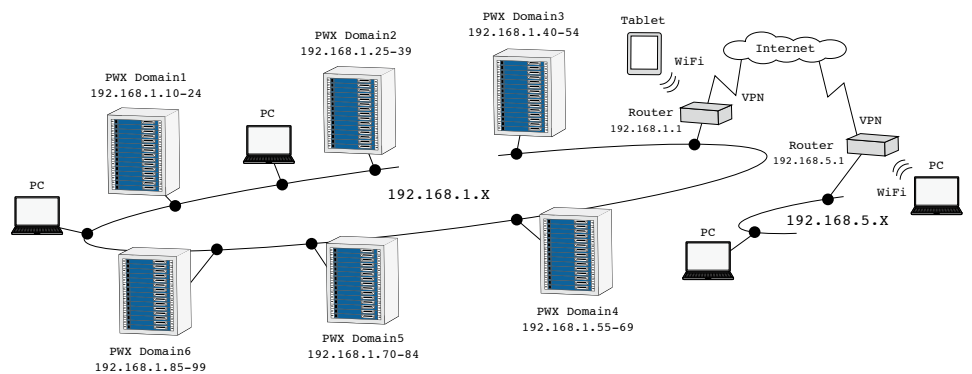

● Security for LAN connections

Access to the built-in web server can be restricted with a password. Also, when using VXI-11, HiSLIP, and SCPI-RAW for control, host restrictions can be set with the IP address. It is possible to prevent access from any terminal other than the ones registered as a host (up to 4 hosts can be registered).

● LAN Interface

The LAN interface can control the number of devices with high speed, and it's theoretical controllable maximum number is to be calculated by approximately 4.2 billion. (The maximum transmission speed varies by the number of connected devices) In accordance with its applied standard, it is possible to combine the device that is to control or to be controlled, it is also the feature that can be used with various applications. Also, in computers installed with Apple Bonjour, it is possible to access with a host name instead of the IP address.

● **AUTO MDIX function**: The PWX series can automatically identify the type of LAN cable whether straight or cross is connected and it connects using the appropriate method.

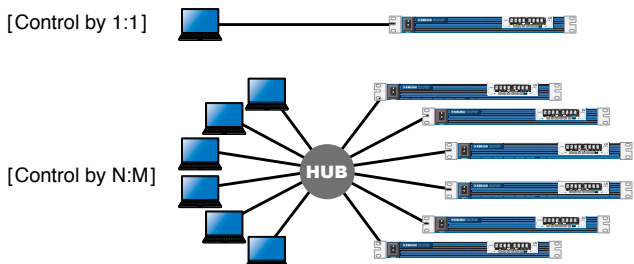

● USB Interface

The USB interface has a feature of high versatility, and the ease of a setup. The automatic recognition by the plug and play releases a user from the complex setting operation under the digital control, and it can be suitable interface when control by 1:1. In accordance with the standard, the maximum number of the connected devices can be configured up to 127 units. Moreover, the USB interface of the PWX series complies to USB2.0, and it has realized transmission speed of a maximum of 12 Mbps (es) (Full Speed).

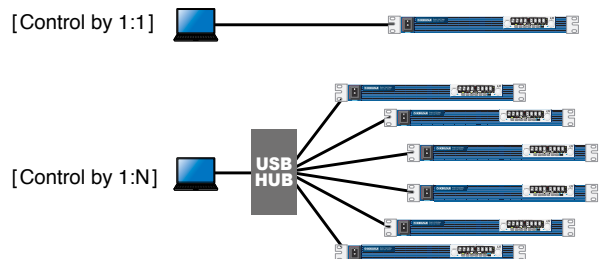

network-based remote control and monitoring

● Easy access with the built-in web server

Use a browser from a PC, smartphone, or tablet to access the web server built into the PWX series for convenient control and monitoring.

[Recommended browser]

- Requires for the Internet Explorer version 9.0 or later
- Requires for the firefox 8.0 or later
- Requires for the safari/mobile Safari 5.1 or later
- Requires for the Chrome 15.0 or later
- Requires for the Opera 11.0 or later

* Connecting with a smartphone, tablet, etc. requires a Wi-Fi environment (wireless LAN router etc.).

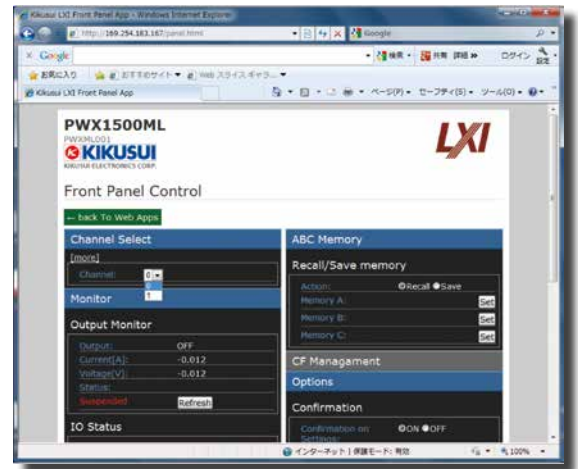

● Application Software

Sequence Creation Software SD013-PWX (Wavy for PWX)

**The software that supports to the auto testing of the power supply.
Allows you to create and edit sequence data easily using a mouse !**

SD013-PWX (Wavy for PWX) is an application software that supports sequence creation and the operation for Kikusui power supplies and electronic loads. Wavy allows you to create and edit sequences visually with a mouse without programming knowledge. It enables you to control the power supply in much the same way as remote controller for such monitoring the voltage and current, logging and so on.

Global commands can be used for batch control of VMCB-connected PWX power supplies!

[Operating environment, conditions]

- Number of power supplies or electronic loads that the Wavy can control is limited to one unit.
- * When a VMCB connection is used, the slave units are controlled at the same time the master unit is controlled.
- CPU: Pentium 4 HT or better (Recommended: Core2 or better)
- CD-ROM: Necessary to install the "Wavy"
- Mouse: Necessary ● Monitor: 1024 x 768 dots or higher resolution
- Memory: 128MB or more ● Interfaces: LAN, USB, RS-232C

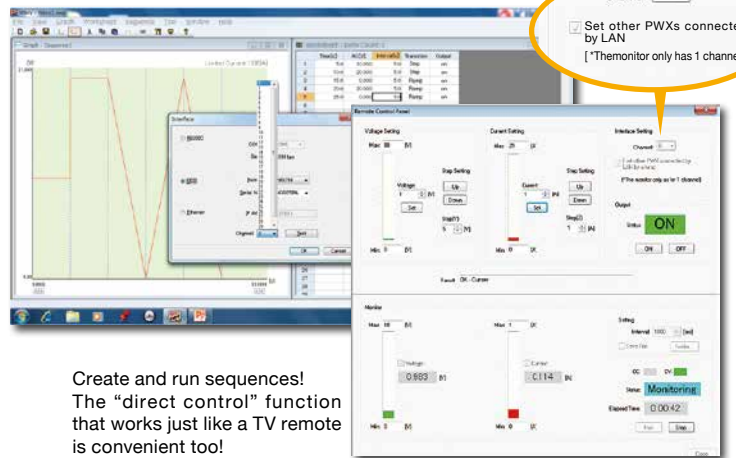

Create and run sequences!
The "direct control" function that works just like a TV remote is convenient too!

● RS232C Interface

The PWX series is also equipped with a RS232C connector. It can be used for communication with PCs and sequencers. Since the PWX series has a RJ45 connector, it is required for a separate D-sub 9P-RJ45 adapter cable (RD-8P/9P).

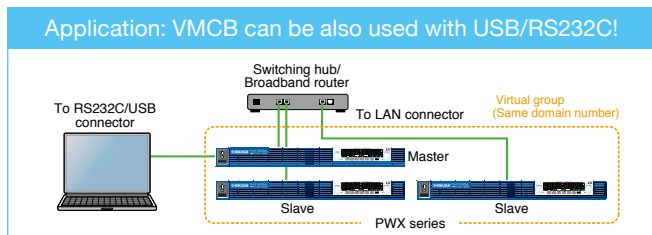
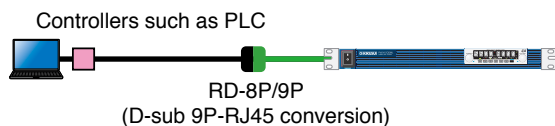

Emulation setting Command language setting function

Emulate devices from companies around the world!

The command language and the emulation which are used at the time of remote control can be set. When the emulation setting is selected, the digital remote control is possible as a substitute of other manufacturer's device. Furthermore, the RS232C interface corresponds to other products by setting the command language into a LGCy language.

Emulation setting	*IDN? The contents of reply
nonE	KIKUSUI, PWX750ML, PWX00003, VER01.00 BLD0134
5700	Agilent Technologies, N5748A, PWX00003, A.01.00
Gen	LAMBDA, GENH80-28-USB, S/N: PWX00003, REV: 1U: 1.00-AP0134
PAG	KIKUSUI, PAGH80-28-USB, S/N: PWX00003, REV: 1U: 1.00-AP0134

The operating range can be varied the ratio of 3 times within its output power rating with a

● Operating Range

● 3 times output power rating

A wide range of voltage and current settings can be combined within its output power rating (3 times).

For example, the output power of 1500 W model, the PWX1500ML is capable to operate seamlessly from the range of "80 V-18.75 A" to "26.8 V-56 A".

《Operating range conceptual diagram》

[PWX750LF/PWX1500L]

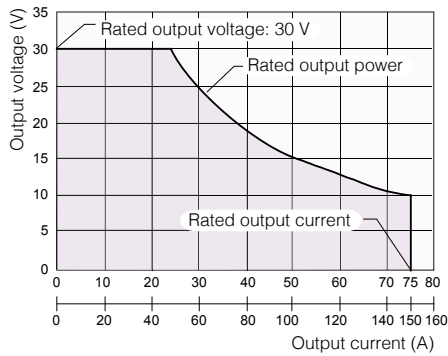

[PWX750ML(MLF)/PWX1500ML]

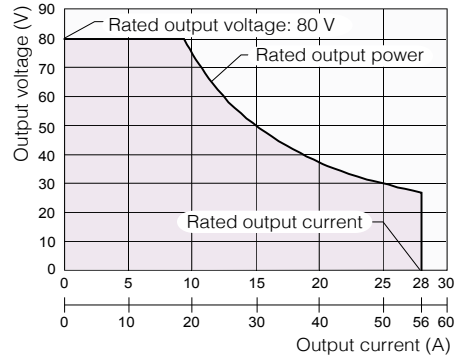

[PWX750MHF/PWX1500MH]

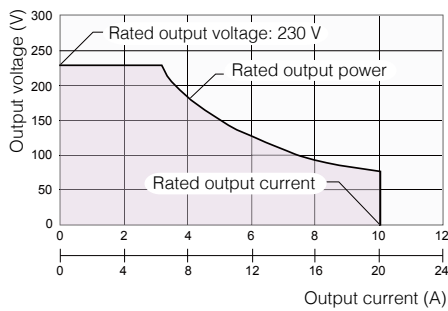

[PWX750HF/PWX1500H]

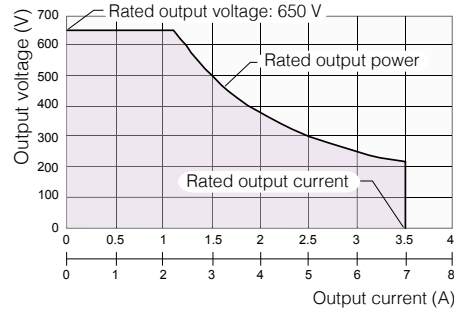

Model type	Rated voltage range	Sample of the rated output voltage	750W		1500W	
L (LF)	10 to 30 V	10V	75 A to 25 A	75A	150 A to 50 A	150A
		12.5V		60A		120A
		15V		50A		100A
		20V		37.5A		75A
		30V		25A		50A
ML (MLF)	26.8 to 80 V	26.8V	28 A to 9.37 A	28A	56 A to 18.75 A	56A
		30V		25A		50A
		35V		21.4A		42.8A
		40V		18.75A		37.5A
		45V		16.66A		33.33A
		60V		12.5A		25A
		80V		9.375A		18.75A
MH (MHF)	75 V to 230 V	75V	10 A to 3.26 A	10A	20 A to 6.52 A	20A
		80V		9.375A		18.75A
		100V		7.5A		15A
		150V		5A		10A
		200V		3.75A		7.5A
		230V		3.26A		6.52A
H (HF)	214.2 V to 650 V	214.2V	3.5 A to 1.153 A	3.5A	7 A to 2.307 A	7A
		300V		2.5A		5A
		400V		1.875A		3.75A
		500V		1.5A		3A
		600V		1.25A		2.5A
		650V		1.153A		2.307A

full range of functions that make it suitable as a test power supply



Space Comparison

- This product replaces multiple single-range units!

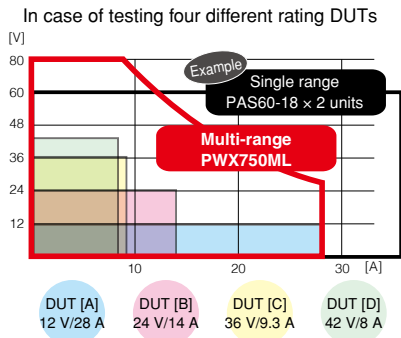
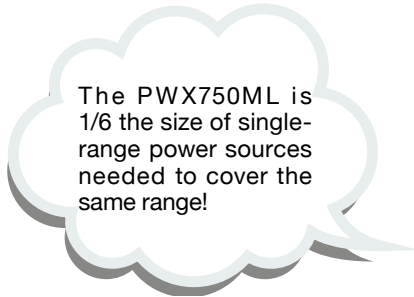

- Comparison of PWR1600L and PWX1500L

Model	13.8V	27.6V	30V	100A	58A	53A	Weight
PWR1600L							15kg
PWX1500L				108A	54A	50A	9.5kg
PWX1500L x 3 PCS				326A	163A	150A	

Extending the capacity

- Series Operation

You can connect up to two units in series. The total of the output voltages of the two units is applied to the load. The voltage setting accuracy is the same as the accuracy of an individual unit. *You cannot perform master-slave configuration in series operation. *Excluding the PWX750HF and the PWX1500H.

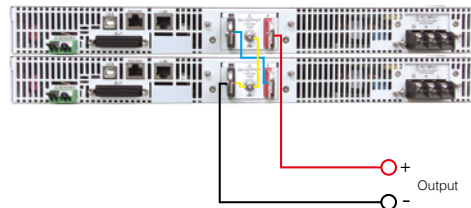

Practical convenient functions are equipped as standard features.

- Bleeder on/off function

The capacitor is connected to the output terminal of the PWX series, and the bleeder circuit is equipped to discharge the electric charge when the OUTPUT is OFF. For example, when the battery is connected to the output terminal, even if it is in the state of OUTPUT OFF, when the bleeder circuit is set to ON, the bleeder circuit will discharge electric charges of the battery. In this case, excessive electric discharge can be prevented by setting the bleeder circuit to OFF state. It is possible to omit the diode for reverse current prevention required for the charge of such a battery.

- A startup state setup at the time of output ON

You can set for the priority operation mode (CC (constant current) priority/CV (constant voltage)) when the output is turned ON. It prevents the overshooting when the output is turned ON.

- Preset memory function

The preset memory function allows you to save up to three combination of each preset value of voltage, current, OVP, OCP, and UVL. The saved preset value can be called from the preset memory on the front panel.

- Master-Slave Parallel Operation

In master-slave parallel operation, one unit is the master unit, and all other units connected in parallel are slave units. The master and slave units must all be the same model. You can control the whole system by operating the master. You can use master-slave parallel operation to increase the output current (maximum output current: the rated output current of one unit x the number of units connected in parallel). You can connect up to four units, including the master, in parallel.

The difference in the output voltage and output current between the master unit and the slave units is within approximately 5 % of the rating.

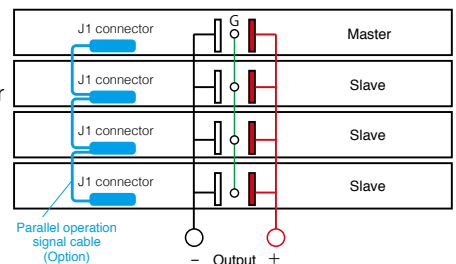

- Parallel operation signal cable

- For 2 units in parallel (PC01-PWX)
- For 3 units in parallel (PC02-PWX)
- For 4 units in parallel (PC03-PWX)



● Analog Interface

The PWX series is equipped with external voltage/resistance control, which are interfaces necessary for analog external control and monitoring applications for test power supply devices. The input external signal and the output status signal can be conducted through the J1 connector on the rear panel.

[Analog remote control application]

● Controlling the Output Voltage & Output Current.

▼ Control using an external voltage.

It is possible to control the output voltage/output current of the PWX series by using an external voltage.

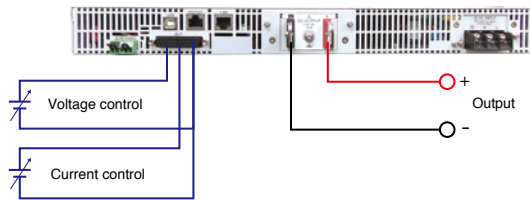

▼ Control using an external resistance.

It is possible to control the output voltage/output current of the PWX series by using an external variable resistor.

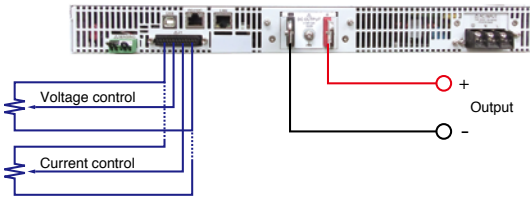

▼ Turning output on and off using an external contact.

It is possible to turn the output ON/OFF of the PWX series by using an external contact.

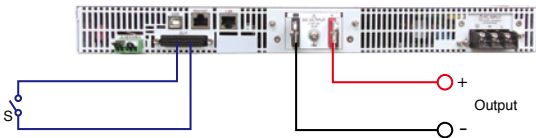

▼ Output shutdown control using an external contact.

It is possible to turn the output OFF of the PWX series by using an external contact.

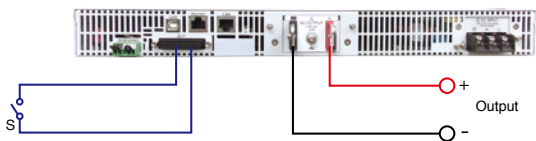

▼ Clearing alarms using an external contact. (Excluding OVP2, OHP2, SD)

It is possible to clear the alarm of the PWX series by using an external contact.

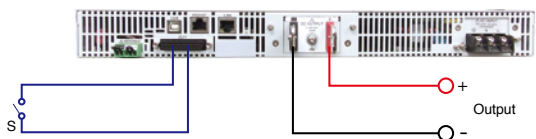

▼ Monitoring operation modes

External monitoring of the output voltage and output current

J1 connector pin arrangement

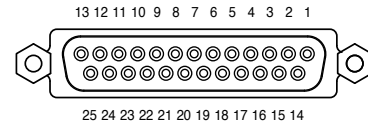

Pin no.	Signal name	Description
1	STATUS COM	Status signal common for pins 2, 3, and 14 to 16.
2	CV STATUS	On when the PWX series is in CV mode (open-collector output from a photocoupler).*1
3	CC STATUS	On when the PWX series is in CC mode (open-collector output from a photocoupler).*1
4	N.C.	Not connected.
5	ALM CLR	Alarm clear terminal. Alarms are cleared when a low TTL level signal is applied to this terminal.
6	SHUT DOWN	Output shutdown control terminal. The output is turned off when a low TTL level signal is applied to this terminal.
7	PRL IN-	Negative input terminal for master-slave parallel operation.
8	PRL IN+	Positive input terminal for master-slave parallel operation.
9	PRL COMP IN	Correction signal input terminal for master-slave parallel operation.
10	A COM	External signal common for pins 5 to 9, 11 to 13, 20 to 22, 24, and 25. During remote sensing, this is the negative electrode (-S) of sensing input. When remote sensing is not being performed, this is connected to the negative output.
11	PRL OUT+	Positive electrode output terminal for master-slave parallel operation.
12	PRL COMP OUT	Correction signal output terminal for master-slave parallel operation.
13	I SUM	Current signal terminal for master-slave parallel operation.
14	ALM STATUS	On when a protection function (OVP, OCP, OHP, FAN, SEN, or AC_FAIL) has been activated or when an output shutdown signal is being applied (output through an open-collector photocoupler).*1
15	PWR ON STATUS	Outputs a low level signal when power is turned on (CF11: 0) or when power is turned off (CF11: 1; output through an open-collector photocoupler).*1
16	OUT ON STATUS	On when output is on (output through an open-collector photocoupler).*1
17	N.C.	Not connected.
18	OUT ON/OFF CONT	Output on/off terminal. On (or off) when a low (or high) TTL level signal is applied.
19	A COM	External signal common for pins 5 to 9, 11 to 13, 20 to 22, 24, and 25. During remote sensing, this is the negative electrode (-S) of sensing input. When remote sensing is not being performed, this is connected to the negative output.
20	REF OUT	External resistance control terminal; 5.25 V (CF07: Lo) or 10.5 V (CF07: Hi).
21	I PGM	Terminal used to control the output current with an external voltage or external resistance. 0 V to 5 V; 0 % to 100 % of the rated output current (CF07: Lo). 0 V to 10 V; 0 % to 100 % of the rated output current (CF07: Hi).
22	V PGM	Terminal used to control the output voltage with an external voltage or external resistance. 0 V to 5 V; 0 % to 100 % of the rated output voltage (CF07: Lo). 0 V to 10 V; 0 % to 100 % of the rated output voltage (CF07: Hi).
23	A COM	External signal common for pins 5 to 9, 11 to 13, 20 to 22, 24, and 25. During remote sensing, this is the negative electrode (-S) of sensing input. When remote sensing is not being performed, this is connected to the negative output.
24	I MON	Output current monitor. 0 % to 100 % of the rated output current is generated as a voltage between 0 V and 5 V (CF08: Lo) or a voltage between 0 V and 10 V (CF08: Hi).
25	V MON	Output voltage monitor. 0 % to 100 % of the rated output voltage is generated as a voltage between 0 V and 5 V (CF08: Lo) or a voltage between 0 V and 10 V (CF08: Hi).

*1 Open collector output: Maximum voltage of 30 V and maximum current of 8 mA. The status common is floating (isolation voltage of 60 V or less), it is isolated from the control circuit.

● Isolated Analog Interface (factory option)

The optional isolated analog interface can be installed upon request at the time of an order. You can use a signal that is isolated from the reference potential of the PWX to control the output voltage/current, turning output on/off, and output shutdown control using an external contact, and output voltage/current monitoring. This option can be selected from the voltage control type (0 V to 5 V or 0 V to 10 V) or the current control type (4 mA to 20 mA).

Panel Description

Front Panel

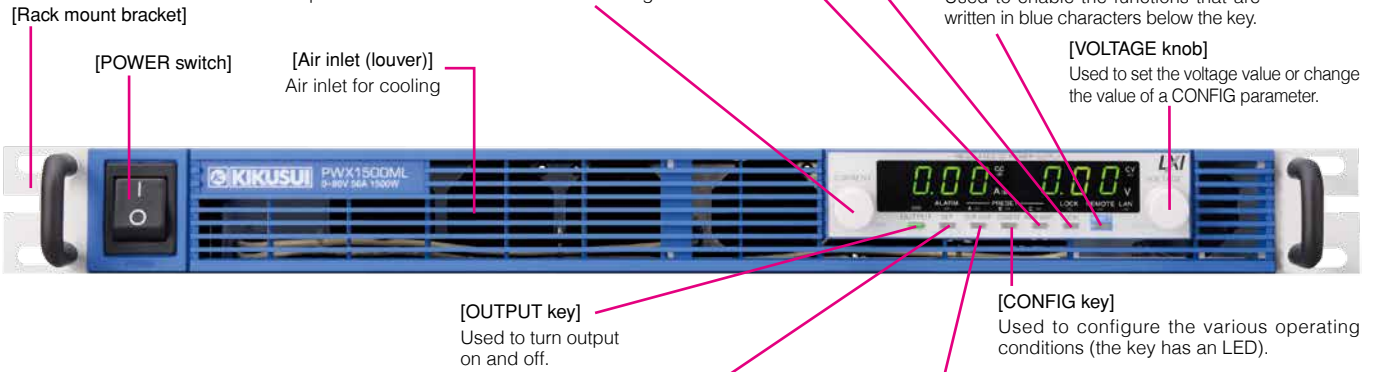

Rear Panel

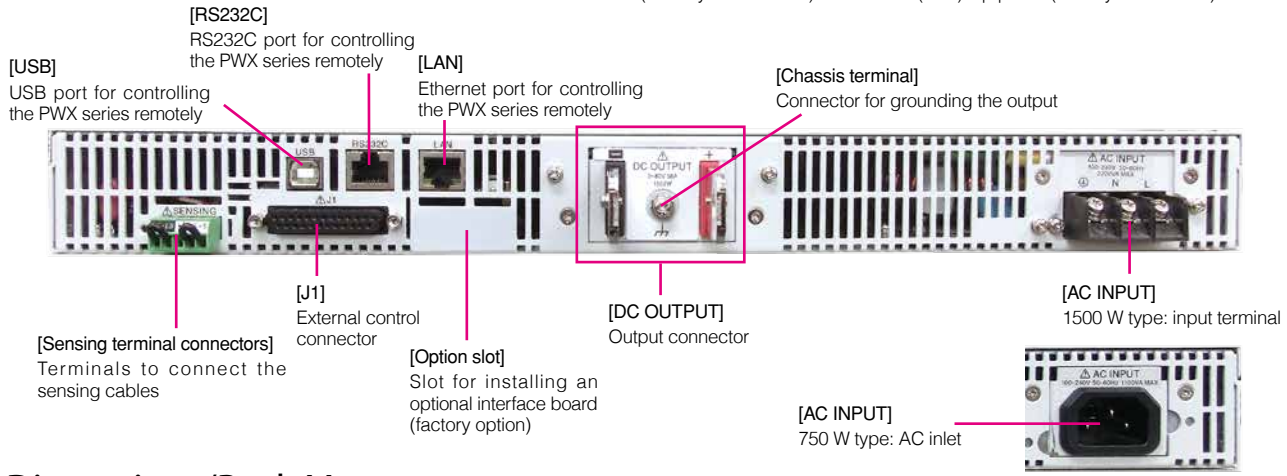

Dimensions/Rack Mount

PWX750ML (Half Rack size)

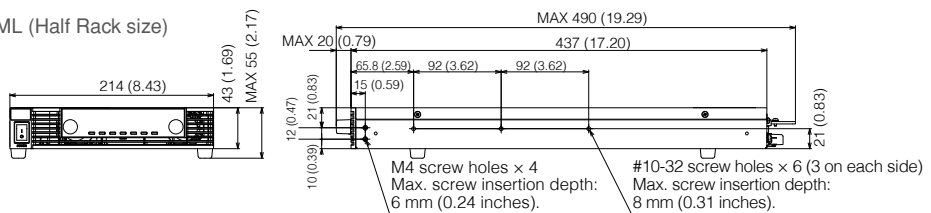

PWX750LF, PWX750MLF, PWX750MHF, PWX750HF, PWX1500L, PWX1500ML, PWX1500MH, PWX1500H

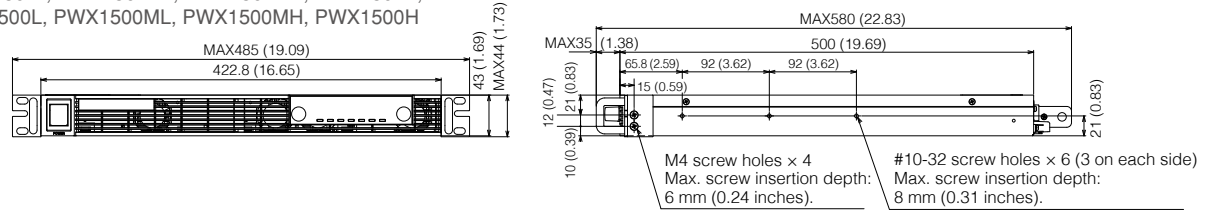

Rack mount adaptor KRA1-PWX HALF SINGLE

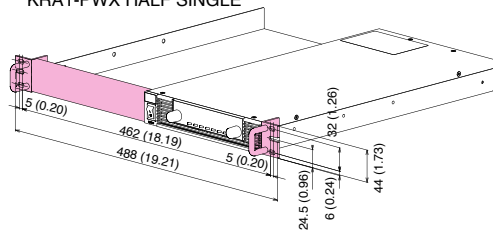

Rack mount adaptor KRA1-PWX HALF PAIR

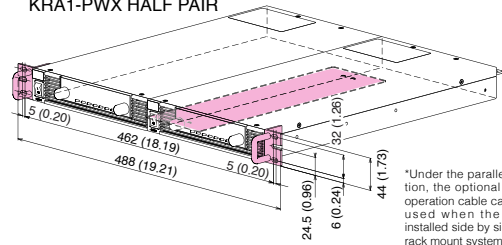

- Brackets
KRB1-PWX
- Thin support angle
KRB1-PWX SUPPORT ANGLE

*Under the parallel operation, the optional parallel operation cable can not be used when the unit is installed side by side in the rack mount system.

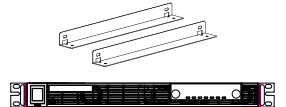

PWX series Variable Internal Resistance Feature

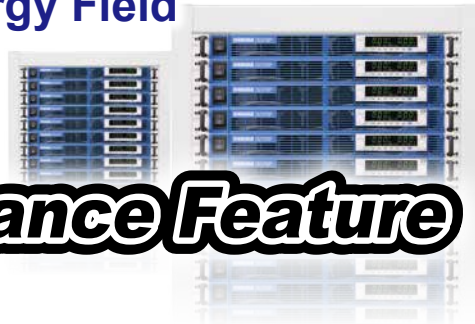

(Factory option)

Variable Internal Resistance Feature



The variable internal resistance feature enables you to easily simulate the internal resistance of rechargeable batteries, solar batteries, fuel cells, and the like. By setting the internal resistance value in constant voltage (CV) mode, you can decrease the output voltage according to the output current. You can use a CONFIG setting to set the internal resistance.

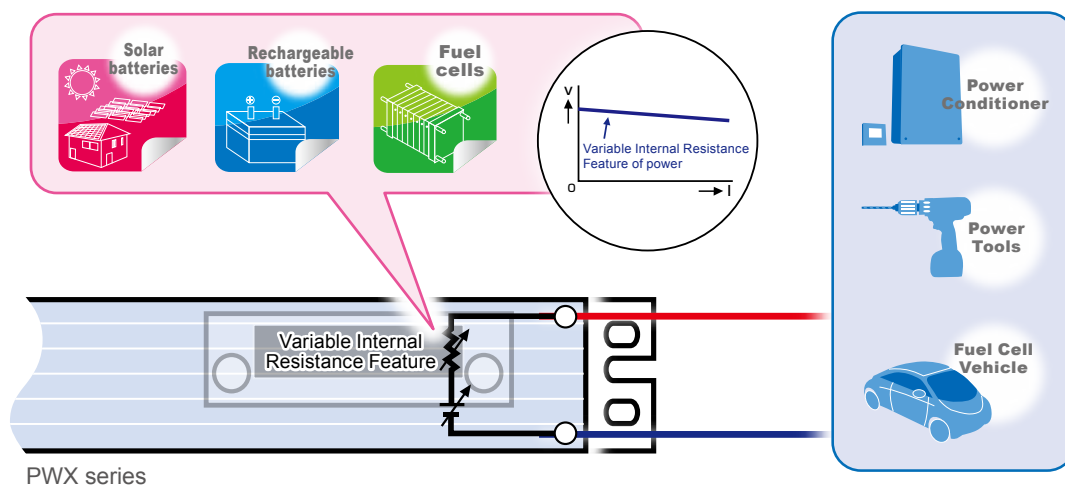

● Variable Internal Resistance Feature

model			
PWX750LF	PWX750MLF	PWX1500L	PWX1500ML
PWX750MHF	PWX750HF	PWX1500MH	PWX1500H

* Factory option

* Excluding the PWX750ML

[Variable range]

Rint : Internal resistance

$0 < Rint \leq Rint \text{ (max)}$

	PWX750LF	PWX750MLF	PWX750MHF	PWX750HF	PWX1500L	PWX1500ML	PWX1500MH	PWX1500H
Rint (min) [Ω]	0.0001 *1	0.001	0.01	0.1	0.0001 *1	0.001	0.01	0.1
Rint (max) [Ω]	0.4000 *1	2.857	23.00	185.7	0.2000 *1	1.429	11.50	92.9
Resolution [Ω]	0.0001 *1	0.001	0.01	0.1	0.0001 *1	0.001	0.01	0.1

*1 When the value is set from the front panel, the least significant digit is not shown on the panel display.

The value varies at a higher resolution than what is shown, and the least significant digit is rounded and shown in the next higher digit.

The maximum internal resistance that can be set from the front panel during parallel operation is the value obtained by dividing Rint (max) during standalone operation by the number of units in parallel operation.

The resolution is the value obtained by dividing the resolution during standalone operation by the number of units in parallel operation.

[Specifications]

	PWX750LF	PWX750MLF	PWX750MHF	PWX750HF	PWX1500L	PWX1500ML	PWX1500MH	PWX1500H
Maximum internal resistance that can be set Rint (max) [Ω]	0.400	2.857	23.00	185.7	0.200	1.429	11.50	92.9

Option



AC power cord for PWX750ML
(For Japan and U.S.)
AC2-3P3M-IEC320-UL



AC power cord for PWX750ML
(For Europe)
AC1-3P2R5M-IEC320-EU



AC power cord for PWX750ML
(For China)
AC1-3P2R5M-IEC320-CN



1500 W model AC power cord
(3 m)
AC5.5-3P3M-M4C-VCTF



Rack mount adapter for 1U half
independent packaging
KRA1-PWX HALF SINGLE



Rack mount adapter for 1U half
interconnected packaging
KRA1-PWX HALF PAIR



Thin support angle
KRB1-PWX SUPPORT ANGLE



Parallel operation cable
(For 2 units in parallel)
PC01-PWX



Parallel operation cable
(For 3 units in parallel)
PC02-PWX



Parallel operation cable
(For 4 units in parallel)
PC03-PWX



RS232C control conversion cable
(D-sub 9p female-RJ45, 2 m)
RD-8P/9P

Order Information

Lineup

Type	Model	Voltage output	Current output
750 W	PWX750LF	0 to 30 V	0 to 75 A
	PWX750ML	0 to 80 V	0 to 28 A
	PWX750MLF	0 to 80 V	0 to 28 A
	PWX750MHF	0 to 230 V	0 to 10 A
	PWX750HF	0 to 650 V	0 to 3.5 A
1500 W	PWX1500L	0 to 30 V	0 to 150 A
	PWX1500ML	0 to 80 V	0 to 56 A
	PWX1500MH	0 to 230 V	0 to 20 A
	PWX1500H	0 to 650 V	0 to 7 A



Isolated analog interface (factory option)
Voltage control type
ISO PROG VOLT CONT PWX OPTION
Current control type
ISO PROG CURR CONT PWX OPTION

Option * One AC cable suitable for the country in question is included standard with the 750 W type. (Excluding PWX750ML)
If another cable is required, please order it as an optional accessory.

Product	Model	Remark
AC power cord for PWX750ML	AC2-3P3M-IEC320-UL	For Japan and U.S., with plug, total length 3 m (rated voltage 125 V/rated current 15 A)
	AC1-3P2R5M-IEC320-EU	For Europe, with plug, total length 2.5 m (rated voltage 250 V/rated current 10 A)
	AC1-3P2R5M-IEC320-CN	For China, with plug, total length 2.5 m (rated voltage 250 V/rated current 10 A)
1500 W model AC power cord	AC5.5-3P3M-M4C-VCTF	3 m
Rack mount adapter for 1U half independent packaging	KRA1-PWX HALF SINGLE	
Rack mount adapter for 1U half interconnected packaging	KRA1-PWX HALF PAIR	
Thin support angle	KRB1-PWX SUPPORT ANGLE	For our cosmetic rack KRC/KRO Series 1U type cohesive packaging
Parallel operation cable	PC01-PWX	For 2 units in parallel
	PC02-PWX	For 3 units in parallel
	PC03-PWX	For 4 units in parallel
RS232C control conversion cable	RD-8P/9P	D-sub 9P to female-RJ45
Isolated analog interface	Voltage control type	Factory option.
	Current control type	Factory option.
Sequence Creation Software	SD013-PWX (Wavy for PWX)	

Specifications

750 W type

Item/Model	PWX750LF	PWX750MLF	PWX750MHF	PWX750HF
Half rack size		PWX750ML		
AC input				
Nominal input rating	100 Vac to 240 Vac, 50 Hz to 60 Hz, single phase			
Input voltage range	85 Vac to 265 Vac			
Input frequency range	47 Hz to 63 Hz			
Current (MAX) *1	100 Vac	10.5 A		
	200 Vac	5.25 A		
Inrush current (MAX) *2	70 A peak or less			
Power (MAX) *3	1100 VA			
Power factor (TYP) *1	0.99 (input voltage 100 V), 0.97 (input voltage 200 V)			0.98 (input voltage 100 V), 0.96 (input voltage 200 V)
Efficiency (MIN) *1	74 % or more			
Hold-up time for power interruption (MIN) *3	20 ms or greater			

*1. With rated load. *2. Excludes the charge current component that flows through the capacitor of the internal EMC filter circuit immediately after the POWER switch is turned on (for approximately 1 ms). *3. 100 Vac with rated load.

Item/Model	PWX750LF	PWX750MLF	PWX750MHF	PWX750HF	
Half rack size		PWX750ML			
Output					
Rating	Output voltage *1	30 V	80 V	230 V	
	Output current *1	75 A	28 A	10 A	
	Output power	750 W			
Voltage	Setting range	0 V to 31.5 V	0 V to 84 V	0 V to 241.5 V	
	Setting accuracy	± (0.05 % of set + 0.05 % of rating)			
	Line regulation *2	± 5 mV	± 10 mV	± 25 mV	± 67 mV
	Load regulation *3	± 5 mV	± 10 mV	± 25 mV	± 67 mV
	Transient response *4	1 ms or less		7 ms or less	
	Ripple noise *5	(p-p) *6	60 mV	80 mV	120 mV
		(rms) *7	8 mV	8 mV	25 mV
	Rise time	Rated load	100 ms		
		No load	100 ms		
	Fall time *8	Rated load	100 ms	150 ms	250 ms
		No load	450 ms	1500 ms	3000 ms
	Maximum remote sensing compensation voltage (single line)	1.5 V	4 V	5 V	5 V
	Temperature coefficient (MAX) *9	100 ppm/°C (during external control)			
Current	Setting range	0 A to 78.75 A	0 A to 29.4 A	0 A to 10.5 A	
	Setting accuracy	±(0.5 % of set + 0.1 % of rating)			
	Line regulation	± 9.5 mA	± 4.8 mA	± 3 mA	± 2.35 mA
	Load regulation	± 20 mA	± 10.6 mA	± 7 mA	± 5.7 mA
	Ripple noise *10 (rms) *7	150 mA	65 mA	30 mA	15 mA
	Temperature coefficient (TYP) *9	100 ppm/°C			

*1. The maximum output voltage and current are limited by the maximum output power. *2. 85 Vac to 135 Vac or 170 Vac to 265 Vac, fixed load. *3. The amount of change that occurs when the load is changed from no load to rated load (rated output power/rated output voltage) with rated output voltage. The value is measured at the sensing point. *4. The amount of time required for the output voltage to return to a value within "rated output voltage ± (0.1 % + 10 mV)." The load current fluctuation is 50 % to 100 % of the maximum current with the set output voltage. *5. Measured using an RC-9131 1:1 probe that conforms to the JEITA specifications. At the rated output current. *6. When the measurement frequency bandwidth is 10 Hz to 20 MHz. *7. When the measurement frequency bandwidth is 5 Hz to 1 MHz. *8. When the breeder circuit on/off setting is on. *9. When the ambient temperature is within 0 °C and 50 °C. *10. When the output voltage (Rated Power ÷ Rated Current) is 10 % to 100 % of the rating. At the rated output current.

Item/Model	PWX750LF	PWX750MLF	PWX750MHF	PWX750HF
Half rack size		PWX750ML		
Display function				
Voltage display	Maximum display	99.99 (fixed decimal point)		999.9 (fixed decimal point)
	Display accuracy	± (0.2 % of reading + 5 digits)		
Current display	Maximum display	99.99 (fixed decimal point)		9.999 (fixed decimal point)
	Display accuracy	± (0.5 % of reading + 5 digits)		
Power display *1	Maximum display	The PWR DSPL key lights in red.		
	Display accuracy	9999		
Operation display	Displays the result of multiplying the current and voltage			
Operation display	OUTPUT ON/OFF, CV operation, CC operation, Alarm operation, Remote operation (LAN operation), Key lock operation, Preset memory			

*1. Press PWR DSPL to display the power on the ammeter. Each time you press this key, the display switches between power and current.

Item/Model	PWX750LF	PWX750MLF	PWX750MHF	PWX750HF
Half rack size		PWX750ML		
Protection functions				
Overvoltage protection (OVP), Overvoltage protection 2 (OV2P), Overcurrent protection (OCP), Undervoltage limit (UVL), Overheat protection (OHP), Overheat protection 2 (OHP2), Fan failure protection (FAN), Incorrect sensing connection protection (SENSE), Low AC input protection (AC-FAIL), Shutdown (SD), Power limit (POWER LIMIT)				
Signal output				
Monitor signal output *1	Voltage monitor (VMON)	Selectable monitor voltage range: 0 V to 5 V or 0 V to 10 V		
	Setting accuracy	2.5 % of f.s.		
	Current monitor (IMON)	Selectable monitor voltage range: 0 V to 5 V or 0 V to 10 V		
	Setting accuracy	2.5 % of f.s.		
Status signal output *1*2	OUTON STATUS, CV STATUS, CC STATUS, ALM STATUS, PWR ON STATUS			

*1. J1 connector on the rear panel. *2. Photocoupler open collector output; maximum voltage 30 V, maximum current (sink) 8 mA; isolated from the output and control circuits; status commons are floating (withstand voltage of less than or equal to 60 V); and status signals are not mutually isolated.

750 W type

Item/Model	PWX750LF	PWX750MLF	PWX750MHF	PWX750HF
Half rack size		PWX750ML		
Control features				
External control *1	Output voltage control (VPGM)	0 % to 100 % of the rated output voltage Selectable control voltage range: 0 V to 5 V or 0 V to 10 V		
	Accuracy	5 % of f.s.		
	Output current control (IPGM)	0 % to 100 % of the rated output current Selectable control voltage range: 0 V to 5 V or 0 V to 10 V		
	Accuracy	5 % of f.s.		
	Output on/off control [OUTPUT ON/OFF CONT]	Possible logic selections: turn the output on using a low TTL level signal or turn the output on using a high TTL level signal		
Output shutdown control [SHUT DOWN]	Turns the output off with a low TTL level signal			
Alarm clear control [ALM CLR]	Clears alarms with a low TTL level signal			

*1. J1 connector on the rear panel

Item/Model	PWX750LF	PWX750MLF	PWX750MHF	PWX750HF
Half rack size		PWX750ML		
Control features				
Master-slave parallel operation	Including the master unit, up to four units(all the same model) can be connected.			
Series operation*1	Up to two units (all the same model) can be connected.			
Preset memory	Up to three sets of the following settings can be saved: the set voltage, the set current, the set OVP, the set OCP, and the set UVL.			
Key lock	Locks the operation of all keys other than the OUTPUT key.			
Interface				
Software protocol	IEEE Std 488.2-1992			
Command language	Complies with SCPI Specification 1999.0 Has a compatibility mode (switchable)*2 ·Genesys Series made by TDK-Lambda ·N5700/N8700 made by Agilent Technologies ·PAG Series made by Kikusui			
RS232C, USB, LAN	USBTMC-USB488, LXI 1.3 Class C			

*1. Excluding the PWX750HF *2. This setting does not guarantee compatibility with all measuring instrument application software and drivers.

Item/Model	PWX750LF	PWX750MLF	PWX750MHF	PWX750HF
Half rack size		PWX750ML		
General				
Environmental conditions	Operating environment	Indoor use, overvoltage category II		
	Operating temperature/humidity	0 °C to +50 °C/20 %rh to 85 %rh (no condensation)		
	Storage temperature/humidity	-10 °C to +60 °C (ML only -20 °C to +70 °C)/90 %rh or less (no condensation)		
	Altitude	Up to 2000 m		
Cooling method	Forced air cooling using fan			
Grounding polarity	Negative grounding or positive grounding possible			
Isolation voltage		± 250 Vmax	± 500 Vmax	± 800 Vmax
	Isolated analog interface *1	± 60 Vmax		
Withstand voltage	Input-FG	No abnormalities at 1500 Vac for 1 minute		
	Input-Output	No abnormalities at 2000 Vac for 1 minute		No abnormalities at 2250 Vac for 1 minute
	Output-FG	No abnormalities at 1500 Vdc (ML only 500 Vdc) for 1 minute	No abnormalities at 1600 Vac for 1 minute	No abnormalities at 2000 Vac for 1 minute
	Input-Isolated analog interface *1	No abnormalities at 2650 Vac for 1 minute		
	Output-Isolated analog interface *1	No abnormalities at 2300 Vdc (ML only 500 Vdc) for 1 minute	No abnormalities at 2650 Vac for 1 minute	No abnormalities at 3300 Vac for 1 minute
Insulation resistance		500 Vdc, 100 MΩ or more(70 % or less)		1000Vdc, 100 MΩ or more(70 % or less)
	Output-FG	500 Vdc, 40 MΩ or more(70 % or less)		1000Vdc, 40 MΩ or more(70 % or less)
Safety *2	Complies with the requirements of the following directive and standard. Low Voltage Directive 2014/35/EU EN 61010-1 (Class I *3, Pollution degree 2)			
Electromagnetic compatibility (EMC) *2	Complies with the requirements of the following directive and standard. EMC Directive 2014/30/EU EN 61326-1 (Class A *4), EN 55011 (Class A *4, Group 1 *5) EN 61000-3-2, EN 61000-3-3 Applicable under the following conditions The maximum length of all cabling and wiring connected to the PWX series must be less than 3 m.			
Dimensions (maximum)/Weight	422.8(485) Wx43(44) Hx500(580) Dmm/Approx. 8 kg		422.8(485) Wx43(44) Hx500(580) Dmm/Approx. 7.5 kg	
Half rack size	214 Wx43(55) Hx437(490) Dmm/Approx. 5 kg			
Accessories	AC cable *6: 1 wire, Output terminal cover: 1 pc., Output terminal M8 bolt set: M8 bolts x2 sets(Bolt, nut, spring washer, and washer for each bolt) *PWX750ML includes M6 bolt set, Chassis connection wire: 1 wire, J1 connector plug kit: 1 set (Housing: 1 pc., Connector: 1 pc., Plug: 1 pc., Strain relief: 1 pc., Clips: 2 pcs., and two types of Screws: 2 pcs.), Packing list: 1 copy, Quick reference (1 each for English and Japanese), Safety precautions: 1 copy, China RoHS sheet: 1 copy, CD-ROM: 1 disc			

*1. Option *2. Only on models that have the CE marking on the panel. Does not apply to specially ordered or modified PWXs. *3. This is a Class I equipment. Be sure to ground this product's protective conductor terminal. The safety of this product is only guaranteed when the product is properly grounded. *4. This is a Class A equipment. This product is intended for use in an industrial environment. This product may cause interference if used in residential areas. Such use must be avoided unless the user takes special measures to reduce electromagnetic emissions to prevent interference to the reception of radio and television broadcasts. *5. This is a Group 1 equipment. This product does not generate and/or use intentionally radio-frequency energy, in the form of electromagnetic radiation, inductive and/or capacitive coupling, for the treatment of material or inspection/analysis purpose. *6. AC cable is option for PWX750ML.

Specifications

1500 W type

Item/Model	PWX1500L	PWX1500ML	PWX1500MH	PWX1500H
AC input				
Nominal input rating	100 Vac to 240 Vac, 50 Hz to 60 Hz, single phase			
Input voltage range	85 Vac to 265 Vac			
Input frequency range	47 Hz to 63 Hz			
Current (MAX) *1	100 Vac	21 A		
	200 Vac	10.5 A		
Inrush current (MAX) *2	75 A peak or less			
Power (MAX) *3	2200 VA			
Power factor (TYP) *1	0.99 (input voltage 100 V), 0.97 (input voltage 200 V)			0.98 (input voltage 100 V), 0.96 (input voltage 200 V)
Efficiency (MIN) *1	74 % or more			
Hold-up time for power interruption (MIN) *3	20 ms or greater			

*1. With rated load. *2. Excludes the charge current component that flows through the capacitor of the internal EMC filter circuit immediately after the POWER switch is turned on (for approximately 1 ms). *3. 100 Vac with rated load.

Item/Model	PWX1500L	PWX1500ML	PWX1500MH	PWX1500H		
Output						
Rating	Output voltage *1	30 V	80 V	230 V	650 V	
	Output current *1	150 A	56 A	20 A	7 A	
	Output power	1500 W				
Voltage	Setting range	0 V to 31.5 V	0 V to 84 V	0 V to 241.5 V	0 V to 682.5 V	
	Setting accuracy	± (0.05 % of set +0.05 % of rating)				
	Line regulation *2	± 5 mV	± 10 mV	± 25 mV	± 67 mV	
	Load regulation *3	± 5 mV	± 10 mV	± 25 mV	± 67 mV	
	Transient response *4	1 ms or less			7 ms or less	
	Ripple noise *5	(p-p) *6	60 mV	80 mV	120 mV	330 mV
		(rms) *7	8 mV			60 mV
	Rise time	Rated load	100 ms			
		No load	100 ms			
	Fall time *8	Rated load	100 ms	150 ms	250 ms	
		No load	800 ms	1500 ms	3000 ms	
	Maximum remote sensing compensation voltage (single line)	1.5 V	4 V	5 V	5 V	
Temperature coefficient (MAX) *9	100 ppm/°C (during external control)					
Current	Setting range	0 A to 157.5 A	0 A to 58.8 A	0 A to 21 A	0 A to 7.35 A	
	Setting accuracy	± (0.5 % of set +0.1 % of rating)				
	Line regulation	± 17 mA	± 7.6 mA	± 4 mA	± 2.7 mA	
	Load regulation	± 35 mA	± 16.2 mA	± 9 mA	± 6.4 mA	
	Ripple noise *10 (rms) *7	300 mA	130 mA	60 mA	30 mA	
Temperature coefficient (TYP) *9	100 ppm/°C					

*1. The maximum output voltage and current are limited by the maximum output power. *2. 85 Vac to 135 Vac or 170 Vac to 265 Vac, fixed load. *3. The amount of change that occurs when the load is changed from no load to rated load (rated output power/rated output voltage) with rated output voltage. The value is measured at the sensing point. *4. The amount of time required for the output voltage to return to a value within ± rated output voltage ± (0.1 % + 10 mV). *5. The load current fluctuation is 50 % to 100 % of the maximum current with the set output voltage. *6. Measured using an RC-9131 1:1 probe that conforms to the JEITA specifications. At the rated output current. *7. When the measurement frequency bandwidth is 10 Hz to 20 MHz. *8. When the breeder circuit on/off setting is on. *9. When the ambient temperature is within 0 °C and 50 °C. *10. When the output voltage (Rated Power ÷ Rated Current) is 10 % to 100 % of the rating. At the rated output current.

Item/Model	PWX1500L	PWX1500ML	PWX1500MH	PWX1500H
Display function				
Voltage display	Maximum display	99.99 (fixed decimal point)		999.9 (fixed decimal point)
	Display accuracy	± (0.2 % of reading +5 digits)		
Current display	Maximum display	999.9 (fixed decimal point)	99.99 (fixed decimal point)	9.999 (fixed decimal point)
	Display accuracy	± (0.5 % of reading +5 digits)		
Power display *1	Maximum display	The PWR DSPL key lights in red.		
	Display accuracy	9999 Displays the result of multiplying the current and voltage		
Operation display	OUTPUT ON/OFF, CV operation, CC operation, Alarm operation, Remote operation (LAN operation), Key lock operation, Preset memory			

*1. Press PWR DSPL to display the power on the ammeter. Each time you press this key, the display switches between power and current.

Item/Model	PWX1500L	PWX1500ML	PWX1500MH	PWX1500H
Protection functions				
	Overvoltage protection (OVP), Overvoltage protection 2 (OVP2), Overcurrent protection (OCP), Undervoltage limit (UVL), Overheat protection (OHP), Overheat protection 2 (OHP2), Fan failure protection (FAN), Incorrect sensing connection protection (SENSE), Low AC input protection (AC-FAIL), Shutdown (SD), Power limit (POWER LIMIT)			
Signal output				
Monitor signal output *1	Voltage monitor (VMON)	Selectable monitor voltage range: 0 V to 5 V or 0 V to 10 V		
	Setting accuracy	2.5 % of f.s.		
	Current monitor (IMON)	Selectable monitor voltage range: 0 V to 5 V or 0 V to 10 V		
	Setting accuracy	2.5 % of f.s.		
Status signal output *1*2	OUTON STATUS, CV STATUS, CC STATUS, ALM STATUS, PWR ON STATUS			

*1. J1 connector on the rear panel. *2. Photocoupler open collector output; maximum voltage 30 V, maximum current (sink) 8 mA; isolated from the output and control circuits; status commons are floating (withstand voltage of less than or equal to 60 V); and status signals are not mutually isolated.

● 1500 W type

Item/Model	PWX1500L	PWX1500ML	PWX1500MH	PWX1500H
Control features				
External control *1	Output voltage control (VPGM)	0 % to 100 % of the rated output voltage Selectable control voltage range: 0 V to 5 V or 0 V to 10 V		
	Accuracy	5 % of f.s.		
	Output current control (IPGM)	0 % to 100 % of the rated output current Selectable control voltage range: 0 V to 5 V or 0 V to 10 V		
	Accuracy	5 % of f.s.		
	Output on/off control [OUTPUT ON/OFF CONT]	Possible logic selections: turn the output on using a low TTL level signal or turn the output on using a high TTL level signal		
Output shutdown control [SHUT DOWN]	Turns the output off with a low TTL level signal			
Alarm clear control [ALM CLR]	Clears alarms with a low TTL level signal			

*1. J1 connector on the rear panel

Item/Model	PWX1500L	PWX1500ML	PWX1500MH	PWX1500H
Control features				
Master-slave parallel operation	Including the master unit, up to four units(all the same model) can be connected.			
Series operation*1	Up to two units (all the same model) can be connected.			
Preset memory	Up to three sets of the following settings can be saved: the set voltage, the set current, the set OVP, the set OCP, and the set UVL.			
Key lock	Locks the operation of all keys other than the OUTPUT key.			
Interface				
Software protocol	IEEE Std 488.2-1992			
Command language	Complies with SCPI Specification 1999.0 Has a compatibility mode (switchable)*2 ·Genesys Series made by TDK-Lambda ·N5700/N8700 made by Agilent Technologies ·PAG Series made by Kikusui			
RS232C, USB, LAN	USBTMC-USB488, LXI 1.3 Class C			

*1. Excluding the PWX1500H *2. This setting does not guarantee compatibility with all measuring instrument application software and drivers.

Item/Model	PWX1500L	PWX1500ML	PWX1500MH	PWX1500H
General				
Environmental conditions	Operating environment	Indoor use, overvoltage category II		
	Operating temperature/humidity	0 °C to +50 °C/20 %rh to 85 %rh (no condensation)		
	Storage temperature/humidity	-10 °C to +60 °C/90 %rh or less (no condensation)		
	Altitude	Up to 2000 m		
Cooling method	Forced air cooling using fan			
Grounding polarity	Negative grounding or positive grounding possible			
Isolation voltage		± 250 Vmax	± 500 Vmax	± 800 Vmax
	Isolated analog interface *1	± 60 Vmax		
Withstand voltage	Input-FG	No abnormalities at 1500 Vac for 1 minute		
	Input-Output	No abnormalities at 2000 Vac for 1 minute		No abnormalities at 2250 Vac for 1 minute
	Output-FG	No abnormalities at 1500 Vdc for 1 minute	No abnormalities at 1600 Vac for 1 minute	No abnormalities at 3300 Vac for 1 minute
	Input-Isolated analog interface *1	No abnormalities at 2650 Vac for 1 minute		
	Output-Isolated analog interface *1	No abnormalities at 2300 Vdc for 1 minute	No abnormalities at 2650 Vac for 1 minute	No abnormalities at 3300 Vac for 1 minute
Insulation resistance		500 Vdc, 100 MΩ or more(70 % or less)		1000 Vdc, 100 MΩ or more(70 % or less)
	Output-FG	500 Vdc, 40 MΩ or more(70 % or less)		1000 Vdc, 40 MΩ or more(70 % or less)
Safety *2	Complies with the requirements of the following directive and standard. Low Voltage Directive 2014/35/EU EN 61010-1 (Class I *3, Pollution degree 2)			
Electromagnetic compatibility (EMC) *2	Complies with the requirements of the following directive and standard. EMC Directive 2014/30/EU EN 61326-1 (Class A *4), EN 55011 (Class A *4, Group 1 *5) EN 61000-3-2, EN 61000-3-3 Applicable under the following conditions The maximum length of all cabling and wiring connected to the PWX Series must be less than 3 m.			
Dimensions (maximum)/Weight	422.8(485) W×43(44) H×500(580) Dmm/Approx. 9.5 kg		422.8(485) W×43(44) H×500(580) Dmm/Approx. 9 kg	
Accessories	Output terminal cover: 1 pc., Input terminal cover set, Output terminal M8 bolt set: M8 bolts ×2 sets(Bolt, nut, spring washer, and washer for each bolt), Chassis connection wire: 1 wire, J1 connector plug kit: 1 set(Housing: 1 pc., Connector: 1 pc., Plug: 1 pc., Strain relief: 1 pc., Clips: 2 pcs., and two types of Screws: 2 pcs.), Packing list: 1 copy, Quick reference (1 each for English and Japanese), Safety precautions: 1 copy, China RoHS sheet: 1 copy, CD-ROM: 1 disc			

* A power cord is not included. Please purchase the optional accessory separately (AC5.5-3P3M-M4C-VCTF).

*1. Option *2. Only on models that have the CE marking on the panel. Does not apply to specially ordered or modified PWXs. *3. This is a Class I equipment. Be sure to ground this product's protective conductor terminal. The safety of this product is only guaranteed when the product is properly grounded. *4. This is a Class A equipment. This product is intended for use in an industrial environment. This product may cause interference if used in residential areas. Such use must be avoided unless the user takes special measures to reduce electromagnetic emissions to prevent interference to the reception of radio and television broadcasts. *5. This is a Group 1 equipment. This product does not generate and/or use intentionally radio-frequency energy, in the form of electromagnetic radiation, inductive and/or capacitive coupling, for the treatment of material or inspection/analysis purpose.



KIKUSUI ELECTRONICS CORPORATION

1-1-3, Higashiyamata, Tsuzuki-ku, Yokohama, 224-0023, Japan
Phone: (+81) 45-593-7570, Facsimile: (+81) 45-593-7571, www.kikusui.co.jp

KIKUSUI AMERICA, INC. 1-877-876-2807 www.kikusuiamerica.com



2975 Bowers Avenue, Suite 307, Santa Clara, CA 95051
Phone : 408-980-9433 Facsimile : 408-980-9409

KIKUSUI TRADING (SHANGHAI) Co., Ltd. www.kikusui.cn



Room308,Building 2, No.641,Tianshan Road, Shanghai City, China
Phone : 021-5887-9067 Facsimile : 021-5887-9069

For our local sales distributors and representatives, please refer to "sales network" of our website.

●Distributor/Representative

■ All products contained in this catalogue are equipment and devices that are premised on use under the supervision of qualified personnel, and are not designed or produced for home-use or use by general consumers. ■ Specifications, design and so forth are subject to change without prior notice to improve the quality. ■ Product names and prices are subject to change and production may be discontinued when necessary. ■ Product names, company names and brand names contained in this catalogue represent the respective registered trade name or trade mark. ■ Colors, textures and so forth of photographs shown in this catalogue may differ from actual products due to a limited fidelity in printing. ■ Although every effort has been made to provide the information as accurate as possible for this catalogue, certain details have unavoidably been omitted due to limitations in space. ■ If you find any misprints or errors in this catalogue, it would be appreciated if you would inform us. ■ Please contact our distributors to confirm specifications, price, accessories or anything that may be unclear when placing an order or concluding a purchasing agreement.